

SKLADOVÝ PROGRAM

2010

VÝBĚR Z NOVÝCH KOLEKČÍ
PRO ČESKOU REPUBLIKU
A SLOVENSKOU REPUBLIKU



S I R O[®]

www.siro.cc

HF16	olše
K1	černá
K2	hnědá
K10	bílá
KM1	přírodní – natur
KM3	modrá
MF1	zlatá
MF2	stříbro
MF13	nerez ocel efekt
MT1	stříbro
MT3	zlatá

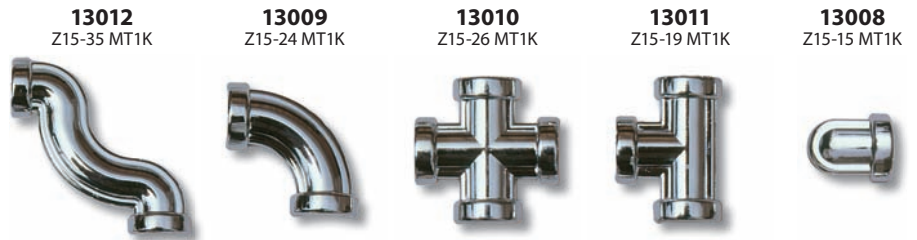
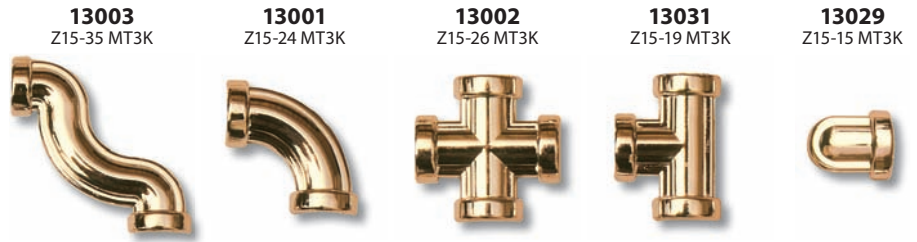

13027
Z15-MF1



13023
Z15-K10MF1



13022
Z15-SK23HF16MF1



13033
Z15-MF2



13025
Z15-K1MF2



13021
Z15-K10K



13045 Z15-35 K10K **13032** Z15-26 K10K **13053** Z15-19 K10K **13047** Z15-15 K10K

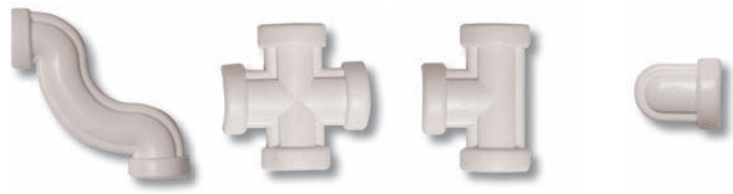

13014 Z22-31 MT3K **13013** Z22-22 MT3K **13015** Z22-26 MT3K **13016** Z22-18 MT3K



13007 Z22-31 MT1K **13004** Z22-22 MT1K **13005** Z22-26 MT1K **13006** Z22-18 MT1K



13019
Z22-K28MF1



13055
Z22-K29MF13



13020
Z22-K29MF2





12015
921-127 ZN1
76 mm



12124
921-127 ZN5
76 mm



12156
921-127 ZN10
76 mm

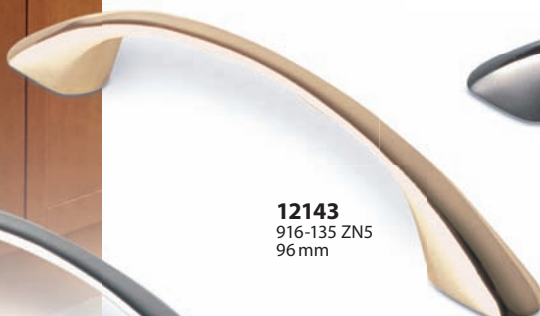

12143
916-135 ZN5
96 mm



12148
916-135 ZN16
96 mm



12144
916-135 ZN1
96 mm



12071
911-72 ZN5
64 mm



12070
1026-135 ZN10
96 mm



12073
911-72 ZN1
64 mm



12142
1026-135 ZN5
96 mm



12086
1026-135 ZN2
96 mm



12122
1026-135 ZN1
96 mm



12138
1026-135 ZN4
96 mm

ZN1	chrom lesk
ZN2	chrom mat
ZN4	nikl mat
ZN5	mosaz lesk
ZN10	staromosaz
ZN16	antracit



KÓDOVÁNÍ VÝROBKŮ

12643	objednací číslo	
typové číslo	velikost	povrchová úprava
1313 - 162	ZN4	
128		
rozetč děr		

ZN1	chrom lesk
ZN2	chrom mat
ZN4	nikl mat
ZN5	mosaz lesk
ZN21	nikl jemně broušený

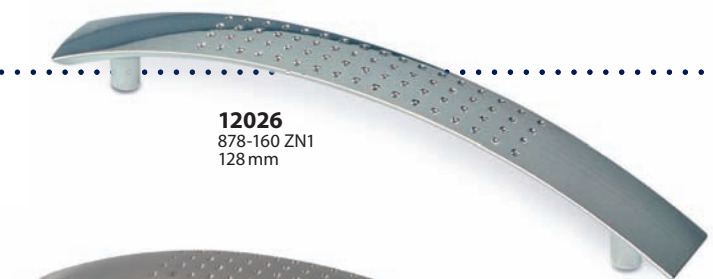



12866
1246-123 ZN21
96 mm



12865
1246-123 ZN4
96 mm



12641
1314-20 ZN1



12864
1246-123 ZN1
96 mm



12621
1314-20 ZN2



12622
1314-20 ZN4



12715
1314-20 ZN21



12770
1313-130 ZN1
96 mm



12642
1313-162 ZN1
128 mm



12927
1313-130 ZN2
96 mm



12303
1313-162 ZN2
128 mm

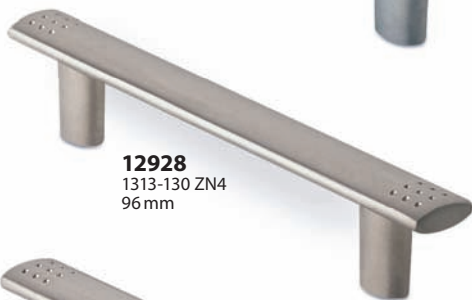

12928
1313-130 ZN4
96 mm



12643
1313-162 ZN4
128 mm



12929
1313-130 ZN21
96 mm



12486
1313-162 ZN21
128 mm

ZN1	chrom lesk
ZN2	chrom mat
ZN4	nikl mat
ZN21	nikl jemně broušený



KÓDOVÁNÍ VÝROBKŮ

12643	objednací číslo	
typové číslo	velikost	povrchová úprava
1313 - 162	128	ZN4
rozetč děr		

ZN1	chrom lesk
ZN4	nikl mat
ZN5	mosaz lesk
ZN16	antracit
ZN21	nikl jemně broušený





12961
1652-35 ZN5



12959
1652-35 PB21



12960
1652-35 ZN4



12962
1652-35 ZN21



12956
1651-113 ZN4
96 mm



12958
1651-113 ZN21
96 mm



12955
1651-113 PB21
96 mm



12957
1651-113 ZN5
96 mm



12714
940-141 ZN5
128 mm



12711
940-141 ZN1
128 mm



12706
940-141 ZN4
128 mm

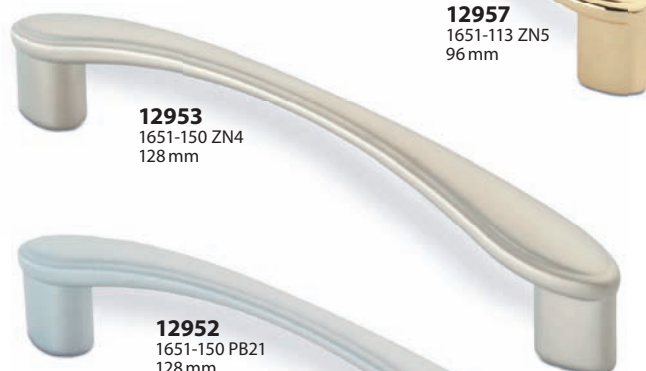

12953
1651-150 ZN4
128 mm



12952
1651-150 PB21
128 mm



12954
1651-150 ZN21
128 mm



12110
814-107 ZN4
96 mm



12109
814-107 ZN1
96 mm

PB21	ALU efekt
ZN1	chrom lesk
ZN4	nikl mat
ZN5	mosaz lesk
ZN21	nikl jemně broušený



KÓDOVÁNÍ VÝROBKŮ

12643 *objednací číslo*

<i>typové číslo</i>	<i>velikost</i>	<i>povrchová úprava</i>
1313 - 162	128	ZN4
	<i>rozetč děr</i>	

ZN1	chrom lesk
ZN2	chrom mat
ZN4	nikl mat
ZN5	mosaz lesk
ZN10	staromosaz
ZN21	nikl jemně broušený



12917
1311-116 ZN21
96 mm



12914
1311-116 ZN2
96 mm



12915
1311-116 ZN4
96 mm



12916
1311-116 ZN5
96 mm



12902
1309-116 ZN2
96 mm



12674
1309-116 ZN4
96 mm

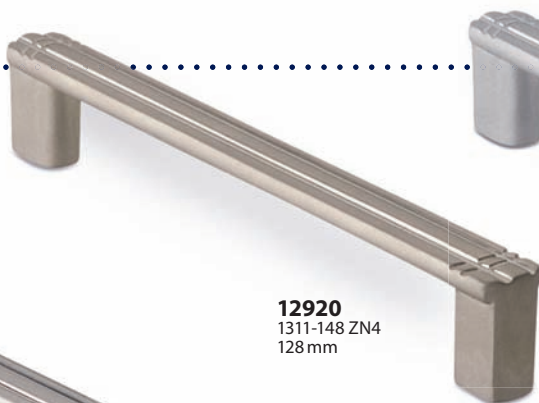

12920
1311-148 ZN4
128 mm



12330
932-16 ZN1



12280
932-16 ZN4



12332
932-16 ZN10



12331
932-16 ZN5



12907
1309-154 ZN4
128 mm



12906
1309-154 ZN2
128 mm



12908
1309-154 ZN21
128 mm



12911
1310-27 ZN4



12910
1310-27 ZN2



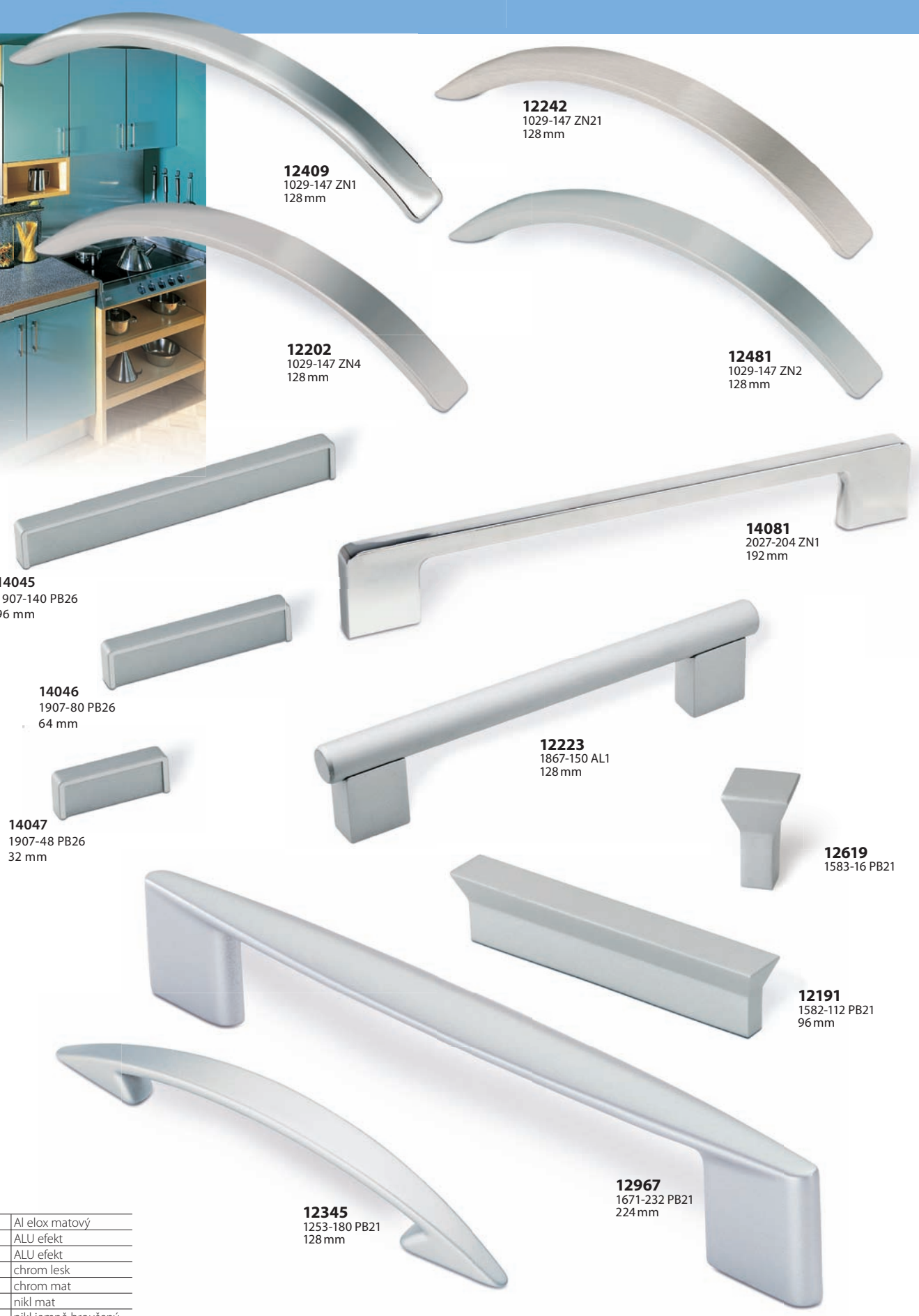

12409
1029-147 ZN1
128 mm

12242
1029-147 ZN21
128 mm

12202
1029-147 ZN4
128 mm

12481
1029-147 ZN2
128 mm

14045
1907-140 PB26
96 mm

14081
2027-204 ZN1
192 mm

14046
1907-80 PB26
64 mm

12223
1867-150 AL1
128 mm

14047
1907-48 PB26
32 mm

12619
1583-16 PB21

12191
1582-112 PB21
96 mm

12345
1253-180 PB21
128 mm

12967
1671-232 PB21
224 mm

AL1	Al elox matový
PB21	ALU efekt
PB26	ALU efekt
ZN1	chrom lesk
ZN2	chrom mat
ZN4	nikl mat
ZN21	nikl jemně broušený

KÓDOVÁNÍ VÝROBKŮ

12643 *objednací číslo*
typové číslo 1313 - *velikost* 162 *povrchová úprava* ZN4
 128
rozetč děr

FE2	železo chromované
PB21	ALU efekt
ZN1	chrom lesk
ZN2	chrom mat
ZN4	nikl mat
ZN5	mosaz lesk
ZN21	nikl jemně broušený
ZN32	zinek lakovaný
ZN33	zelená
ZN34	modrá
ZN35	černá



12677
869-185 ZN5
160 mm



12068
742-124 FE2
104 mm



12013
869-185 ZN1
160 mm



12890
1340-134 ZN2ZN35
96 mm



12624
869-185 ZN4
160 mm



12889
1340-134 ZN1ZN34
96 mm



12885
1339-35 ZN1ZN34



12886
1339-35 ZN2ZN35



12887
1339-35 ZN32ZN33



12436
1666-136 ZN21
128 mm



12891
1340-134 ZN32ZN33
96 mm



12435
1666-136 PB21
128 mm



12443
1791-138 PB21
128 mm



12438
1750-193 PB21
160 mm



12442
1791-138 ZN21
128 mm



12437
1750-193 ZN21
160 mm



12137
1739-202 N1
192 mm

12180
1585-175 N1
160 mm



12140
1739-234 N1
223 mm



12453
1932-178 ZN21
128/160 mm



12105
1863-230 ZN27
192 mm



12106
1863-88 ZN27
64 mm



12328
885-320 ZN2
240 mm



12116
885-320 ZN4
240 mm



12261
885-320 ZN21
240 mm

objednáací č.	typové číslo - délka úprava povrchu	rozteč v mm
12224	885-208 ZN2	128
12327	885-240 ZN2	160
12328	885-320 ZN2	240
12329	885-512 ZN2	432
12688	885-688 ZN2	608

12183	885-178 ZN4	96
12167	885-208 ZN4	128
12139	885-240 ZN4	160
12116	885-320 ZN4	240
12133	885-368 ZN4	288
12111	885-512 ZN4	432
12018	885-688 ZN4	608
12623	885-816 ZN4	736

12282	885-208 ZN21	128
12227	885-240 ZN21	160
12261	885-320 ZN21	240
12184	885-512 ZN21	432
12275	885-688 ZN21	608

N1	nerez
ZN2	chrom mat
ZN4	nikl mat
ZN21	nikl jemně broušený
ZN27	ušlechtilá ocel mat



KÓDOVÁNÍ VÝROBKŮ
12643 *objednáací číslo*

typové číslo	velikost	povrchová úprava
1313 - 162		ZN4
128		
rozteč děr		

AL1	hliník natur matový
PB21	alu efekt
ZN1	chrom lesk
ZN2	chrom mat
ZN21	nikl jemně broušený
ZN51	zinek lakovaný leštěný



14048
1999-49 ZN2
32 mm



14049
1999-273 ZN2
256 mm



14042
1906-340 AL1
320 mm

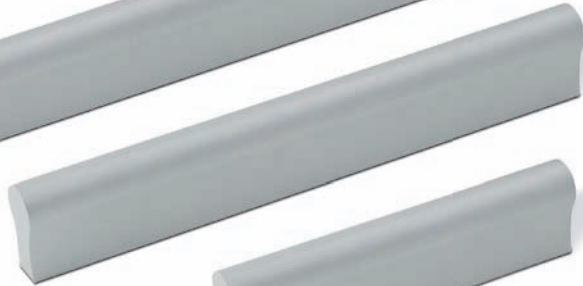

14043
1906-148 AL1
128 mm

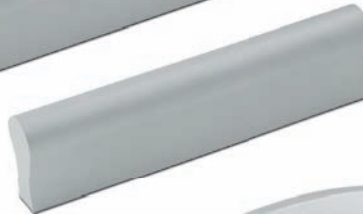

14044
1906-84 AL1
64 mm



14036
1910-209 ZN51
160 mm



14028
1961-168 PB21
128 mm



14037
1910-95 ZN51
64 mm



14029
1962-92 PB21
64 mm



14041
1963-183 ZN51
128 mm



14027
1968-162 ZN51
128 mm



14010
1956-185 ZN1
128 a 160 mm



14011
1956-185 ZN21
128 a 160 mm



14034
1966-227 ZN51
160 mm



14035
1967-41 ZN51



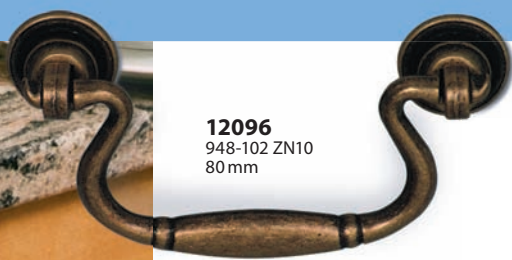

12096
948-102 ZN10
80mm



12040
947-86 ZN10
60mm



12719
959-45 ZN10



12101
949-102 ZN10
75mm

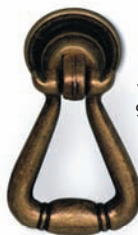

12717
956-40 ZN10



14040
1820-82 ZN31



12934
1469-120 ZN38
64mm



14012
1985-145 ZN31
96mm



14013
1984-30 ZN31



12933
1470-152 ZN38
96mm



12123
1856-135 ZN10
96mm



12352
1268-62 ZN10



12349
1267-115 ZN10
96mm



12351
1268-62 ZN9



12346
1267-115 PB12
96mm



12350
1268-62 PB12

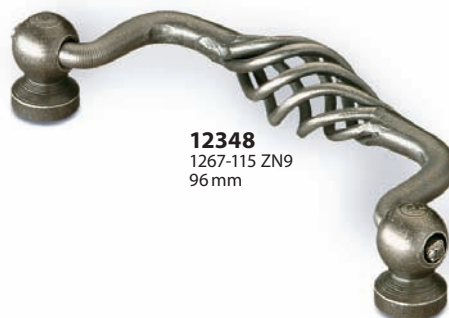

12348
1267-115 ZN9
96mm

PB12	černá
ZN9	starozinek
ZN10	staromosaz
ZN31	staromosaz brynír
ZN38	starobronz



KÓDOVÁNÍ VÝROBKŮ

12643	objednací číslo	
typové číslo	velikost	povrchová úprava
1313 - 162	ZN4	
128	rozetč děr	

ZN5	mosaz lesk
ZN10	staromosaz
ZN21	nikl jemně broušený
ZN28	zinek
ZN43	staromosaz brnír



12963
1631-108 ZN10
96 mm



12337
1225-107 ZN29
64 mm



12178
1567-110 ZN43
96 mm



12336
1207-34 ZN29



14085
812-120 ZN10
96 mm



12673
1533-33 ZN10



14086
812-86 ZN10
64 mm



14087
2007-85 ZN10



12062
1855-34 ZN28



14030
1957-203 ZN10
128 mm



14031
1958-47 ZN10



12571
0452-96 ZN10
96 mm



12049
922-113 ZN10
76 mm



12164
922-113 ZN5
76 mm



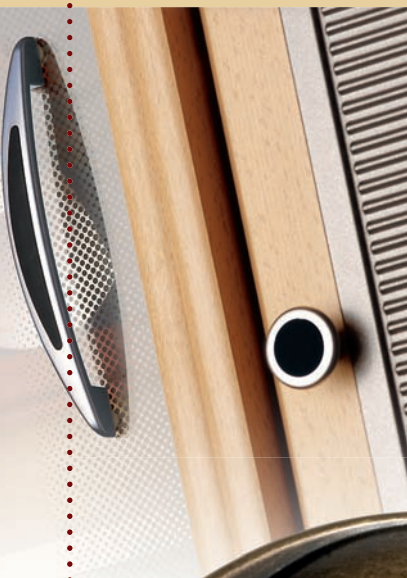

12057
913-32 ZN5



12030
913-32 ZN1



14082
1761-103 ZN29
64 mm



14083
1761-103 ZN10
64 mm



14084
1761-103 ZN27
64 mm

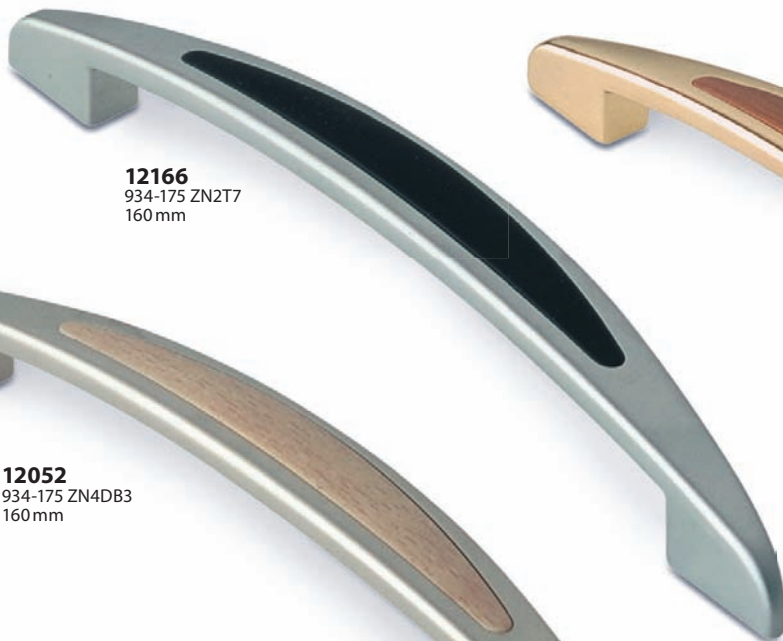

12166
934-175 ZN2T7
160 mm



12165
934-175 ZN5DB1
160 mm



12052
934-175 ZN4DB3
160 mm



12153
939-34 ZN2T7



12046
939-34 ZN4DB3

DB1	olše
DB3	buk
T7	černá
ZN1	chrom lesk
ZN2	chrom mat
ZN4	nikl mat
ZN5	mosaz lesk
ZN10	staromosaz
ZN27	ušlechtilá ocel mat
ZN29	starostříbrná

KÓDOVÁNÍ VÝROBKŮ

12643 objednací číslo

typové číslo 1313 - velikost 162 - povrchová úprava ZN4
128
rozetč děr

A78	porcelán růžový
PC5	porcelán „crack“
PD1	zlatý proužek
PF21	porcelán slonová kost
SP	porcelán bílý
ZN31	staromosaz brnítý
ZN48	staromosaz



12938
1700-29 PC5ZN48



12936
1700-29 PF21ZN48



12935
1699-107 PF21ZN48
96 mm



12937
1699-107 PC5ZN48
96 mm



12231
1881-130 ZN31A78
96 mm



12232
1889-67 ZN31A78



14018
1973-106 ZN31A78
96 mm



12072
SP6-33 SP



14017
1973-138 ZN31A78
128 mm



12113
SP1-33 SPPD1



14020
1972-32 ZN31A78



14038
1918-114 ZN31A78
96 mm



14019
1971-30 ZN31A78



14039
1919-34 ZN31A78





12393
S632-153 H64ZN21
128 mm



12394
S632-153 WL86ZN21
128 mm



12391
R-1000-185 H154ZN21
160 mm



12390
R-1000-185 HZS211ZN21
160 mm



12407
S631-25
HZS211ZN21



12417
S631-25
WL86ZN21



12412
S631-25
H64ZN21



12408
S631-25
H154ZN21



12420
S635-20
HZS211ZN21



12421
S635-20
H154ZN21



12397
S633-32
HZS211ZN21



12399
S633-32
H154ZN21



12401
S633-32
WL86ZN21



12400
S633-32
H64ZN21



12323.3
DS94-20 ZN5 TABÁK



12323.4
DS94-20 ZN5 MAHAGON



12323.5
DS94-20 ZN5 ČERNÁ



12162.2
DS94-20 ZN10 LAK



12162.1
DS94-20 ZN10 SUROVÉ

H64	mahagon tmavý
H154	ořech světlý
HZS211	eben
WL86	olše
ZN5	mosaz lesk
ZN10	staromosaz
ZN21	nikl jemně broušený



KÓDOVÁNÍ VÝROBKŮ

12643	objednací číslo	
typové číslo	velikost	povrchová úprava
1313	162	ZN4
128		
rozetč děr		

H154	ořech světlý
HZ6	borovice lakovaná
HZS211	eben
PB21	ALU efekt
WL90	ořech tmavý
ZN21	nikl jemně broušený



12311
 S597-170 HZS211PB21
 160 mm

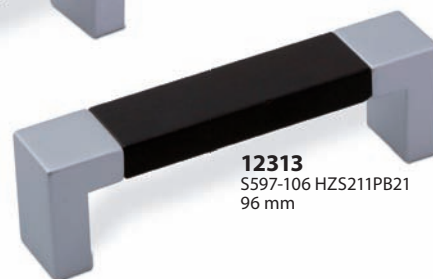

12313
 S597-106 HZS211PB21
 96 mm



12315
 S597-170 WL90PB21
 160 mm



12316
 S597-106 WL90PB21
 96 mm



12359
 S597-170 HZ6PB21
 160 mm

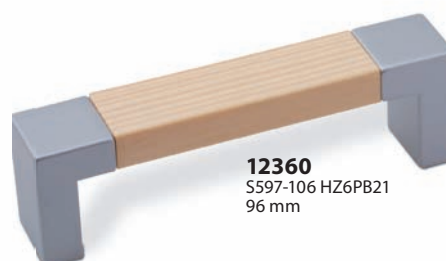

12360
 S597-106 HZ6PB21
 96 mm



12426
 R-1115-143 HZS211ZN21
 96 mm



12434
 R-1115-143 H154ZN21
 96 mm



12422
 R-1115-207 HZS211ZN21
 160 mm



12432
 R-1115-207 H154ZN21
 160 mm





14000
M30 MUŠLE DUB
SUROVÝ



14002
M30 MUŠLE JAVOR
SUROVÝ



14001
M30 MUŠLE BUK
SUROVÝ



14003
M30 MUŠLE SMRK
SUROVÝ



14004
M35 MUŠLE DUB
SUROVÝ



14006
M35 MUŠLE JAVOR
SUROVÝ



14005
M35 MUŠLE BUK
SUROVÝ



14007
M30 MUŠLE SMRK
SUROVÝ



12091
R-1565 MUŠLE BUK



12075
R-1565 MUŠLE DUB

HZ18	buk natur lakovaný
HZ46	buk - ALU efekt
HZS211	eben
LS7	imitace kůže - černá
LS8	imitace kůže - hnědá
LS9	imitace kůže - béžová
WL90	ořech tmavý



12386
R-1005-149 WL90HZ46
128 mm



12381
R-1005-149 HZS211HZ46
128 mm



12530
R-1099-195 HZ18
160 mm



12055
S48-128/96 SMRK
96 mm



12050
S48-182/128 SMRK
128 mm

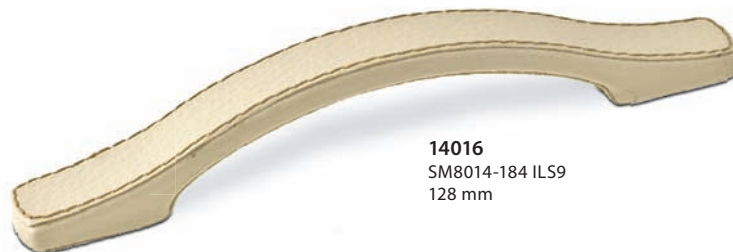

14016
SM8014-184 ILS9
128 mm



14015
SM8014-184 ILS8
128 mm



14014
SM8014-184 ILS7
128 mm



12976
1653 ZN21



12975
1653 ZN4



12974
1653 PB21



12979
1654 ZN21



12978
1654 ZN4



12977
1654 PB21



12758
1280 ZN4



12860
1281 ZN4



12973
1670 ZN21



12971
1670 PB21



12972
1670 ZN4

PB21	ALU efekt
ZN4	nikl mat
ZN21	nikl jemně broušený

SIRO
www.siro.cc

KÓDOVÁNÍ VÝROBKŮ

12643 *objednací číslo*

typové číslo 1313 - *velikost* 162 - *povrchová úprava* ZN4

128
rozetč děr

ZN4	nikl mat
ZN8	brnínř
ZN10	staromosaz



12120
506 ZN10



14088
430 ZN10



12252
1096 ZN4



12121
507 ZN10



14089
431 ZN10



12244
1097 ZN4



12253
1096 ZN10



12333
1096 ZN8



12206
1097 ZN10



12335
1097 ZN8





14072
1871 AL62



12985
1606 ZN21



12984
1606 ZN4



14073
1785 AL62



12987
1607 ZN21



12986
1607 ZN4



12446
745 ZN1



12447
745 ZN5



12981
1604 ZN21



12980
1604 ZN4



12449
746 ZN1



12450
746 ZN5



12983
1605 ZN21



12982
1605 ZN4

AL62	AL elox lesk
ZN1	chrom lesk
ZN4	nikl mat
ZN5	mosaz lesk
ZN21	nikl jemně broušený

KÓDOVÁNÍ VÝROBKŮ

12643 objednací číslo

typové číslo 1313 - velikost 162 - povrchová úprava ZN4
rozetč děr 128

CP2	buk
CP4	třešeň
K1	černá
MV2	ALU efekt
MV11	bílý hliník efekt
T16	modrá



12726
0570-128 | CP4MMV2
96 mm



12731
0570-128 | CP2MMV2
96 mm



12724
0873-34 | CP4M



12729
0873-34 | CP2M



12738
0570-128 | T16MV2
96 mm



12723
097-170 | CP4MMV2
128 mm



12728
097-170 | CP2MMV2
128 mm

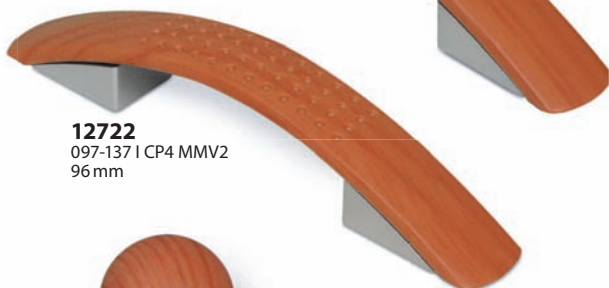

12722
097-137 | CP4 MMV2
96 mm



12727
097-137 | CP2MMV2
96 mm



12725
0453-29 | CP4M
048-33MV2



12650
0065-32 MV2MV2



12739
0453-29 | T16
048-33MV2



12693
0065-32 T16MV2



12730
0453-29 | CP2M
048-33MV2



12737
089-144 T16MV2
128 mm



12944
8059-176 | MV2
160 mm

12159
8086-44 MV2HF60
32 mm

12158
8086-172 MV2HF60
160 mm

12278
8106-168I MV2CP4M
128 mm

12235
8095-148 MV2CP4M
96/128 mm

12281
8106-168I MV2CP195M
128 mm

12237
8095-148 MV2CP195M
96/128 mm

12218
8121-152I MV2HF60
128 mm

12219
8121-152I MV2CP133M
128 mm

12200
8017-271 HF60MV2
256 mm

12325
0428-112 MV2
MUSLE

objednáací č.	typové číslo - délka úprava povrchu	rozeč v mm
12196	8017-143 HF60MV2	128
12198	8017-207 HF60MV2	192

12146
8078-50 MV11
MUSLE

12147
8078-50 K1
MUSLE

12149
8078-50 K10
MUSLE

12324
0235-94 MV2
MUSLE

12134
0196-60 MV2
MUSLE

12066
0235-94 E2
MUSLE

CP4	třešeň
CP133	buk tmavý
CP195	wenge
E2	nikl mat broušený
HF60	wenge
K1	černá
K10	bílá
MV2	ALU efekt
MV11	bílý hliník

KÓDOVÁNÍ VÝROBKŮ
12643 *objednáací číslo*

typové číslo	velikost	povrchová úprava
1313 - 128	162	ZN4
128		
rozeč děr		

AC6	akrylát azur
MF18	ALU efekt
MV2	ALU efekt
MV7	nikl efekt
MV11	bílý hliník efekt
SN1	akrylát čirý
SN9	akrylát oranžový
SN10	akrylát červený
SN16	akrylát modrý

NÁBYTKOVÉ ÚCHYTKY A VĚŠÁKY PLAST



12374
8118-30ISN10MV11



12364
8119-126ISN10MV11
96 mm



12376
8118-30ISN1MV11



12365
8119-126ISN1MV11
96 mm



12230
0859 MV11



12370
8118-30ISN9MV11



12363
8119-126ISN9MV11
96 mm



12001
0858 MV11



12377
8118-30ISN16MV11

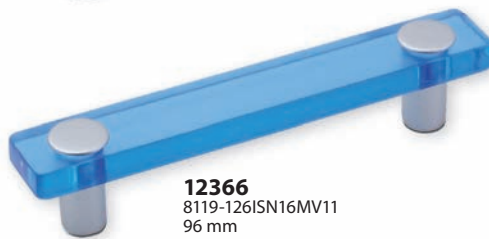

12366
8119-126ISN16MV11
96 mm



12780
8004-164 MV7
128 mm

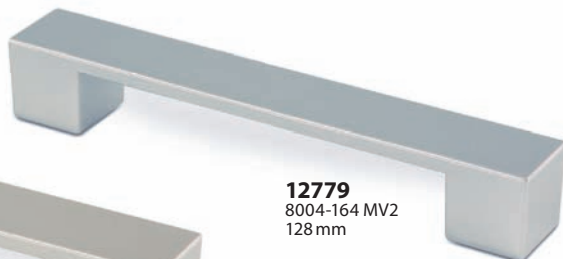

12779
8004-164 MV2
128 mm



12591
8016-141 MF18MV2
128 mm



12697
8016-205 MF18MV2
192 mm



12940
8056-206 AC6MV2
128 mm





14060
8141A-209 | K1HG
160 mm



14062
8141A-209 | MF18
160 mm



14061
8141A-209 | K10HG
160 mm



14063
8141A-209 | MF13
160 mm



14064
8144-64 SK40 MF18
32 mm

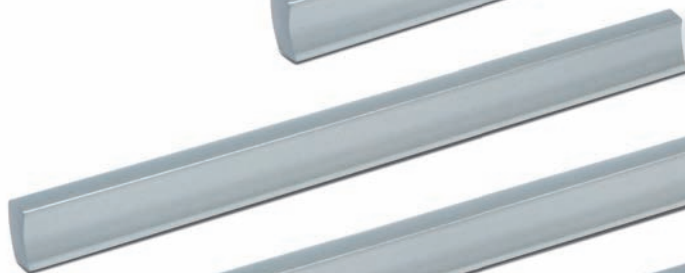

14065
8144-166 SK40 MF18
128 mm



14066
8144-220 SK40 MF18
160 mm



14067
8144-380 SK40 MF18
320 mm



14070
8137-137 GL36
128 mm



14071
8137-137 GL35
128 mm



14068
8137-137 MV2
128 mm



14069
8137-137 MT1
128 mm

K1HG	černá
K10HG	bílá
GL35	bílá lesk
GL36	černá lesk
MF18	ALU efekt
MF13	nerez efekt
MT1	chrom efekt
MV2	ALU efekt
MV7	nikl efekt

KÓDOVÁNÍ VÝROBKŮ

12643 objednací číslo
typové číslo 1313 - velikost 162 - povrchová úprava ZN4
rozetč děr 128

A9 | multicolor



12826
H156-40 RU12



12833
H157-50 RU13



12816
H149-44 RU4



12819
H152-44 RU8



12834
H158-51 RU14



12836
H159-50 RU15



12803
H147-47 RU1



12804
H148-40 RU2



12817
H150-53 RU6

NÁBYTKOVÉ ÚCHYTKY PLAST MĚKČENÝ



12880
H045-40 A9



12882
H047-40 A9



12874
H039-44 A9



12877
H042-42 A9



12883
H048-41 A9



12876
H041-42 A9



12879
H044-42 A9



12875
H040-40 A9



12878
H043-40 A9



12881
H046-47 A9



12884
H049-41 A9

A9 | multicolor

SIRO
www.siro.cc

KÓDOVÁNÍ VÝROBKŮ

12643 objednací číslo

typové číslo	velikost	povrchová úprava
1313	- 162	ZN4
128		
<small>rozetč děr</small>		

A9 | multicolor

NÁBYTKOVÉ ÚCHYTKY A NOHY **PLAST**



12894
H025-57 A9

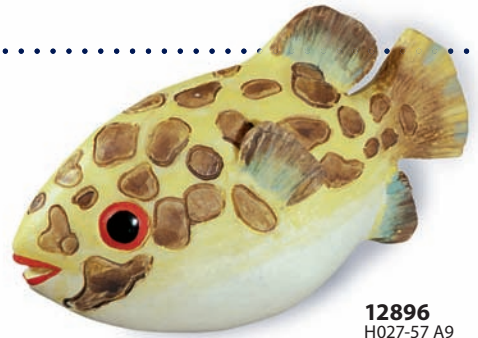

12896
H027-57 A9



12517
H023-55 A9



12895
H026-61 A9



12893
H022-56 A9



12761
H024-65 A9



12797
0719-54 MV7MV7



12798
0719-54 MV2MV2



12403
0082-118 MV2



12474
8110-70 MV2





14075
2035-232 ZN21
224 mm



14077
2035-72 ZN21
64 mm



14074
2035-232 ZN1
224 mm



14076
2035-72 ZN1
64 mm



14078
2042-197 PB21
160 mm



14079
2042-197 ZN1
160 mm



14080
2042-197 ZN21
160 mm

PB21	ALU efekt
ZN1	chrom lesk
ZN21	nikl jemně broušený

SIRO
www.siro.cc

KÓDOVÁNÍ VÝROBKŮ

12643 objednací číslo
typové číslo 1313 - velikost 162 - povrchová úprava ZN4
rozetč děr 128



SAS001



SAS004



SAS005

















SAS006

ALU-STYLE NÁBYTKOVÁ DVÍŘKA A DOPLŇKY

alu-style

ALU RÁMEČKY A DOPLŇKY

UKÁZKY ZE SORTIMENU PROFILŮ ALU-STYLE

<p>SAS001</p>  <p>AL1 GL EE</p> <p>20,6x18,7 mm</p>	<p>SAS008</p>  <p>AL1</p> <p>34,9x17,7 mm</p>	<p>SAS6111</p>  <p>AL1</p> <p>17,3x10 mm</p>
<p>SAS002</p>  <p>AL1</p> <p>34,8x20,6 mm</p>	<p>SAS088</p>  <p>AL1</p> <p>50x22,3 mm</p>	<p>SAS6114</p>  <p>AL1</p> <p>17,3x33,5 mm</p>
<p>SAS003</p>  <p>AL1 GL EE</p> <p>45x20,6 mm</p>	<p>SAS877</p>  <p>AL1</p> <p>50x20,6 mm</p>	<p>SAS1000</p>  <p>AL1</p> <p>11,8x9,5 mm</p>
<p>SAS004</p>  <p>AL1</p> <p>34,9x20,6 mm</p>	<p>SAS099</p>  <p>AL1 EE C35</p> <p>18,5x20,6 mm</p>	<p>SAS6113</p>  <p>AL1 EE</p> <p>32x18 mm</p>
<p>SAS005</p>  <p>AL1</p> <p>19,2x20,6 mm</p>	<p>SAS010</p>  <p>AL1</p> <p>20,6x8 mm</p>	<p>a další...</p>
<p>SAS006</p>  <p>AL1</p> <p>45,8x20,5 mm</p>	<p>SAS011</p>  <p>AL1</p> <p>9x21 mm</p>	<p>POVRCHY PROFILŮ</p>
<p>SAS007</p>  <p>AL1 EE</p> <p>50x20,6 mm</p>	<p>SAS012</p>  <p>AL1</p> <p>2,5x22,3 mm</p>	<p>AL1 matný elox</p>
<p>SAS077</p>  <p>AL1</p> <p>50x20,6 mm</p>	<p>SAS020</p>  <p>AL1</p> <p>20,6x18,7 mm</p>	<p>EE ušlechtilá ocel</p>
		<p>GL lesklý elox</p>
		<p>C35 černá</p>

ANKA - M+N spol. s r.o.
 Jihlavská 1126, CZ-580 01 Havlíčkův Brod
 tel.: 569 434 422, 569 434 420, fax: 569 434 421
 e-mail: anka@ankahb.cz, www.ankahb.cz

ANKA SLOVAKIA spol. s r.o.
 Podzámska 16, SK-949 01 Nitra
 tel.: 37 650 32 10, tel/fax: 37 650 32 11
 e-mail: anka@anka.sk, www.anka.sk

VÝROBKY UVEDENÉ V TOMTO KATALOGU
 JSOU SKLADEM
 K OKAMŽITÉMU ODBĚRU

DODACÍ LHŮTA **OBJEDNÁVEK**

DVÍŘEK A DOPLŇKŮ **ALU-STYLE** JE DVA TÝDNY
 KATALOG S KOMPLETNÍM SORTIMENTEM
 I CENÍKEM ALU-STYLE ZAŠLEME NA POŽÁDÁNÍ.